

S.A.N.E.



2012 CATALOG

Now in Our 36th Year!

Today's Classroom Supplies
at Affordable Prices for your
Family & Consumer
Science Department.

Created and Operated by a
Former Home Economics Teacher.

Visit our website at

www.sanefcs.com



2275 MILLVILLE AVE., SUITE 1
HAMILTON, OH 45013
CALL 800-262-8653 FAX 513-894-3100
sane@fuse.net

CUISINART COOKWARE

CUISINART® CHEF'S CLASSIC™ COOKWARE - Made of premium quality 18/10 stainless steel, professional construction - an aluminum disc in the base is bonded to a stainless steel interior and mirror polished stainless exterior - a fusion of the best materials for cooking. The aluminum encapsulated base maintains even heat distribution, eliminating hot spots.

- 2204 Chef's Classic 7 Pc Set - includes 1½ & 3 qt. covered saucepans, 8 quart covered stock pot and 10" open skillet \$ 119.75
- 2205 Chef's Classic 10 Pc Set - includes 1½ & 3 qt. covered saucepans, 3½ qt. sauté pan w/cover & helper handle, 8 qt. covered saucepot, 8" & 10" skillets, *all at a terrific price* 159.50
- 2201 Chef's Classic 8" Skillet 23.50
- 2202 Chef's Classic 10" Skillet 29.95
- 2203 Chef's Classic 12" Skillet 37.95
- STAINLESS STEEL STOCKPOTS** - Premium quality 18/8 stainless steel wire loop handles, aluminum encapsulated base for even heating,
 - 2210 Chef's Classic 6 Qt. Covered Stockpot 49.95
 - 2211 Chef's Classic 8 Qt. Covered Stockpot 59.95
 - 2212 Chef's Classic 12 Qt. Covered Stockpot 69.95
- STAINLESS STEEL COOKWARE**
 - 2213 Chef's Classic 1½ Qt. Covered Saucepan 21.50
 - 2214 Chef's Classic 3 Qt. Chef's Pan - sloped sides, comes with see thru glass cover 29.95
 - 2215 Chef's Classic 5.5 Qt. Multi-Purpose Pot - great size with lot's of uses, comes with glass cover 39.95
- 2207 Chef's Classic Non-Stick 8" Skillet 26.95
- 2206 Chef's Classic Non-Stick 10" Skillet - non-stick interior for easy fat-free cooking and easy clean-up 37.95
- 2208 Chef's Classic Non-Stick 12" Skillet 59.95

Cuisinart



Comes in 7 piece or 10 piece sets!



2210

Cuisinart Quality!

New!

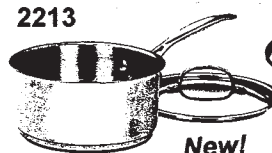

2213

New!



2215

Oven proof handles!



2219

*Hard Anodized Exteriors!
Non-Stick Interiors*

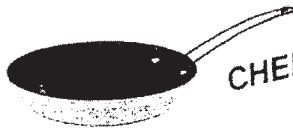

2207

CHEF'S CLASSIC™
from **CUISINART®**

Non-Stick for easy clean-up!

Cuisinart

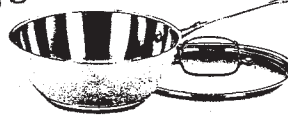

2214

New!

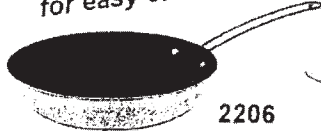

2206



2208



2202

- 2209 Cuisinart Chef's Classic™ Hard Anodized 10 Pc. Set - Cookware exterior is harder than stainless steel and extremely wear resistant. The non-stick interiors are reinforced with titanium for lasting food release and easy clean-up. Safe for use with metal utensils. Cool Grip™ handles stay cool on stovetop, break-resistant glass covers. Set includes 1½ & 3 qt. covered saucepans, 3½ qt. covered sauté pan with helper handle, 8 qt. covered stockpot, 8" & 10" open skillets 169.00
- 2219 Cuisinart Chefs Classic™ Hard Anodized 7 Pc. Set - includes 1½ & 3 qt. covered saucepans, 8 qt. covered stock pot and 10" open skillet, 107.95

Cuisinart
ADVANTAGE
NON-STICK

CUISINART ADVANTAGE NON-STICK COOKWARE - Heavy gauge aluminum heats quickly, cooks at an even temperature, eliminates hot spots, Resilience™ non-stick interiors provide easy food release for healthy cooking and easy clean-up, Easy Grip™ silicone handles to stay cool, tempered glass covers allow you to view cooking action, tight fit lids to seal in flavor, dishwasher safe.

- 2399 Cuisinart Advantage 10 Pc. Set - Includes 1 & 2½ qt. covered saucepans, 3 qt. covered sauté pan, 6 qt. covered stockpot and 8" & 10" open skillets, *A Great Set!!* 99.95



Glass Lids!

10 Piece Set

2399

FARBERWARE COOKWARE

FARBERWARE® CLASSIC COOKWARE - speaks for itself by giving years of durability and quality. Made of gleaming stainless steel with new, fully enclosed, thicker aluminum core bottoms provide enhanced heat distribution. Thicker and bigger rolled edges and rims for extra durability and enhanced drip free pouring. Heat resistant handles and knobs. Superior quality 18/10 stainless steel.

- 2241 17 Piece Set - includes 1, 2 & 3 quart covered saucepans, 4 qt. covered saucepot, 8 qt. covered stockpot, 8" & 10" aluminum open fry pans, 3 piece covered mixing bowl set, plus 9" x 13" cookie sheet & 9" x 13" cake pan \$169.75
- 2242 10 Piece Set - includes 1, 1½ & 2 qt. covered saucepans, 5.5 qt. covered stock pot all with glass lids plus 7" & 9" aluminum open skillet with non-stick interiors, *At a Terrific Price!!* 92.75

OPEN STOCK

- 2245 1 Quart Covered Saucepan 21.75
- 2246 2 Quart Covered Saucepan 24.50
- 2247 3 Quart Covered Saucepan 29.50
- 2248 2 Quart Double Boiler w/cover 35.95

- 2249 4 Quart Covered Saucepot 32.75
- 2250 6 Quart Covered Saucepot 39.95
- 2251 8 Quart Covered Saucepot 46.75
- 2252 12 Quart Covered Saucepot 58.75

- 2255 10" Covered Fry Pan 37.95
- 2256 12" Covered Fry Pan 54.75

- 2234 Sonoma Tea Kettle, 2½ qt. 24.95

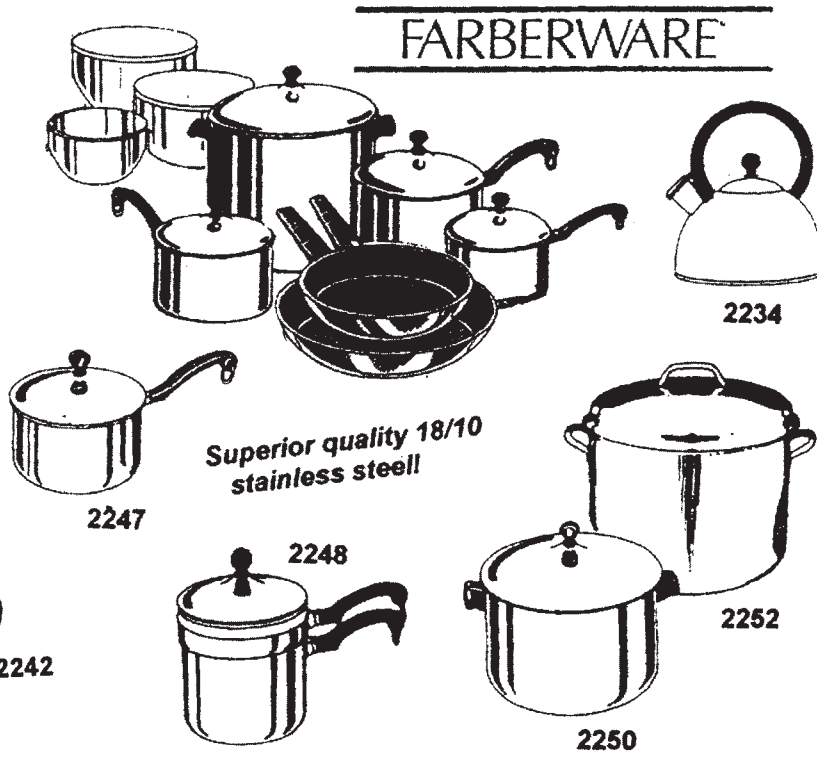

FARBERWARE
Now comes with glass covers!

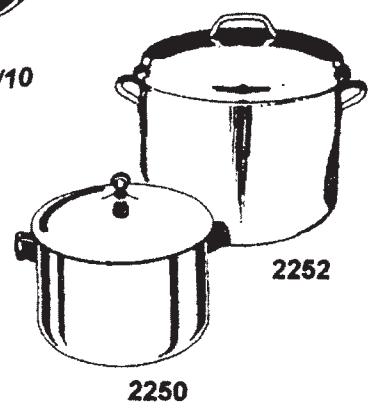
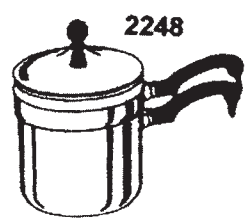
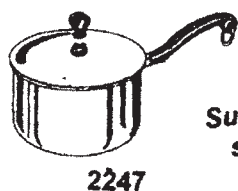
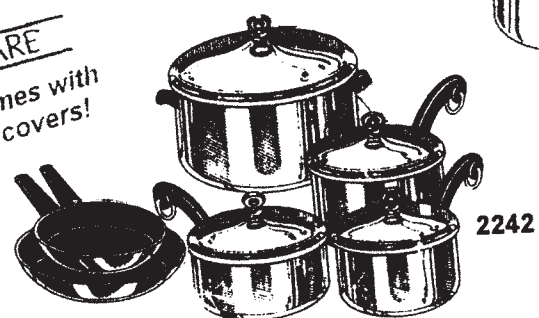

FARBERWARE® MILLENIUM STAINLESS STEEL COOKWARE - An 18/0 stainless steel protector surrounds the thick aluminum base providing perfect heat distribution. Sleek contemporary styling and 18/10 stainless steel construction means durable cookware for years. Bottoms are suitable for induction stovetops! "Soft Touch" silicone enhanced handles are riveted securely to the pan, oven safe to 400°F.

- 2230 Millenium 10 Pc. Set—includes 1, 1½ & 2 qt. covered saucepans, 8 qt. covered stockpot, 8" & 10" open non-stick skillets 129.50
- 2231 Millenium 8" Non-Stick Skillet 24.75
- 2232 Millenium 10" Non-Stick Skillet 29.50
- 2233 Millenium 12" Non-Stick Skillet 39.50

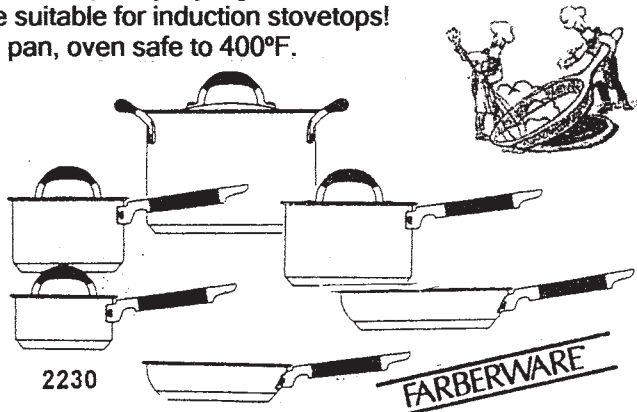
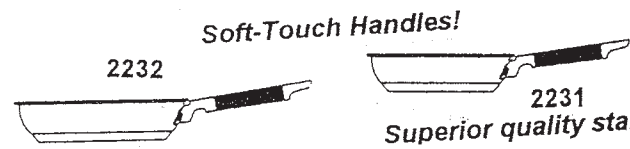

FARBERWARE® SPECIALTIES COOKWARE - Heavy gauge aluminum with distinctive grey non-stick coating inside and out. Riveted Silicone enhanced handles for safety and comfort. Oven safe to 350°F.

- 2296 Farberware 10" Stir Fry Pan 21.75
- 2297 Farberware 11" Square Grill Pan - deep sides, ribbed base for searing and grilling 22.95
- 2299 Farberware 10½" Covered Skillet 26.75

Fashionable and functional!



PROFESSIONAL COOKWARE

HYPERION NON-STICK FRY PANS - The most advanced, toughest non-stick coating made. It out performs and outlasts all other non-stick coatings. Extra-heavy 3.5mm aluminum fry pans is 10% heavier than other 8 gauge fry pans. NSF listed. Includes heat resistant, non-slip rubber handle! Handy hang-up hole.

- 2279 Excalibur 7" Fry Pan \$ 15.95
- 2280 Excalibur 8" Fry Pan 20.95
- 2281 Excalibur 10" Fry Pan 25.95
- 2282 Excalibur 12" Fry Pan 32.95



Each fry pan comes with a heat resistant, non-slip 'sta-kool' handle!!

HYPERION HEAVY DUTY ALUMINUM FRY PANS - Extra-heavy commercial weight (3.5mm) pans have a natural finish. Securely riveted chrome plated handles allow use under broiler. NSF listed. Comes with heat resistant, non-slip rubber handle sleeve. **RESTAURANT QUALITY!**

- 2276 Hyperion 8" Fry Pan 14.95
- 2277 Hyperion 10" Fry Pan 21.95
- 2278 Hyperion 12" Fry Pan 27.95



NORDICWARE RESTAURANT QUALITY NON-STICK SKILLETS - Made of durable, even heating aluminum, non-slip silicone handle with hang-up slot are oven safe to 400°F. Easy clean nonstick interiors, highly polished exteriors. NSF certified!

- 2331 8" Restaurant Skillet \$ 21.95
- 2332 10" Restaurant Skillet 26.95
- 2333 12" Restaurant Skillet 35.75
- 2334 14" Skillet - with helper handle 43.50
- 2335 Square Griddle, 11" 29.95

- 2331
- 2332
- 2333

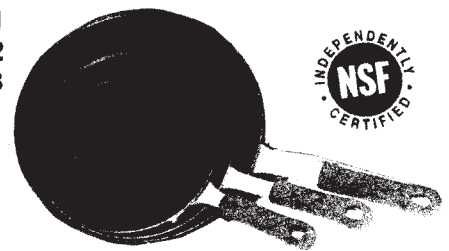
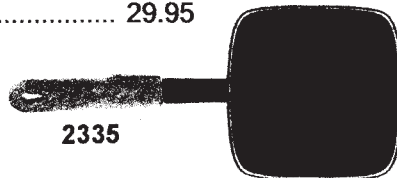

HAMILTON BEACH ELITE NON-STICK COOKWARE - Heavy gauge aluminum covered with 2 coats of non-stick coating inside, silicone polyester exteriors for durability, with grooved bottoms. Riveted comfortable phenolic cool touch handles, tempered glass lids. **NEW LOWER PRICES!!!**

- 2351 Elite 8 Piece Set - includes 1 qt. & 2 qt. cov'd saucepans, 5 qt. Dutch Oven and 8" & 9½" skillets 69.95
- 2352 Elite 2 Qt. Covered Saucepan 14.95
- 2353 Elite 3 Qt. Covered Saucepan 17.95
- 2354 Elite 5 Qt. Covered Dutch Oven 23.95
- 2356 Elite 8" Fry Pan 8.95
- 2357 Elite 9½" Fry Pan 11.95
- 2358 Elite 12" Fry Pan 14.95
- 2359 Elite Square Griddle, 12" 15.95



STAINLESS STEEL COOKWARE

HAMILTON BEACH CONTEMPO COOKWARE - Excellent quality stainless steel, encapsulated aluminum disc bottoms—no hot spots so food cooks evenly, riveted silicone wrapped stainless steel handles, tempered glass lids to allowing viewing while cooking. **NEW LOWER PRICES!!!**

- 2362 Contempo 2 qt. Covered Saucepan 15.95
- 2363 Contempo 3 qt. Covered Saucepan 18.95
- 2364 Contempo 5 qt. Covered Dutch Oven 24.95
- 2366 Contempo 10" Open Skillet 14.95

New Lower Prices!

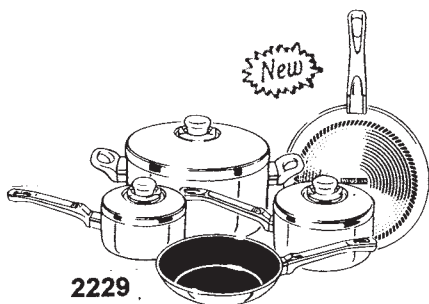

FARBERWARE® HIGH PERFORMANCE NON-STICK COOKWARE - Heavy gauge aluminum construction allows for even heat distribution. SmartGlide™ non-stick reduces abrasion and provides better lasting performance. Glass lids and phenolic handles, safe to 350°F. **New from Farberware!**

- 2229 Farberware® High Performance 10 Piece Set - includes 1 qt., 2 qt. & 3 qt. covered saucepans, 5 qt. cov'd Dutch Oven, 8" & 10" open skillets 89.75

MIRRO GET-A-GRIP COOKWARE - Heavy gauge aluminum for even heating, chip and scratch resistant non-stick interiors, durable non-stick exteriors, comfortable, ergonomic silicone soft-grip, stay cool handles.

- 2301 Get-A-Grip 8" Chef Fry Pan 9.95
- 2302 Get-A-Grip 10" Chef Fry Pan 12.50
- 2303 Get-A-Grip 12" Chef Fry Pan 15.50
- 2304 Get-A-Grip Square Griddle 11" 16.50
- 2306 Get-A-Grip Covered Fry Pan 10" 16.95
- 2305 Covered Jumbo Fryer - 12" (5.3 qt.) 23.95
- 2311 4 Qt. Covered Saucepot 19.75
- 2313 8 Qt. Covered Saucepot 25.50

Non-stick interiors & exteriors! So easy clean-up!

MIRRO

Tempered Glass Lid!

SOFTGRIP



2306



2311

2313

FARBERWARE® PREMIUM NON-STICK COOKWARE - Aluminum construction for even heat distribution, champagne colored non-stick interiors for low-fat cooking and easy clean-up. durable phenolic handles are oven safe to 350°F, glass lids.

FARBERWARE
PREMIUM NONSTICK

- 2228 Farberware® Premium 12 Pc. Set - includes 1½ & 2 qt. covered saucepans, 5 qt. covered Dutch Oven, 2.75 qt. cov'd sauté pan, 10" open skillet, slotted & solid nylon spoons & slotted nylon turner \$ 69.75

New



2228

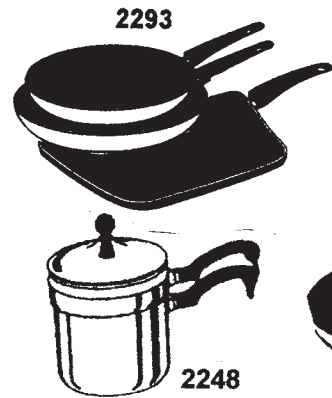

2293

2248

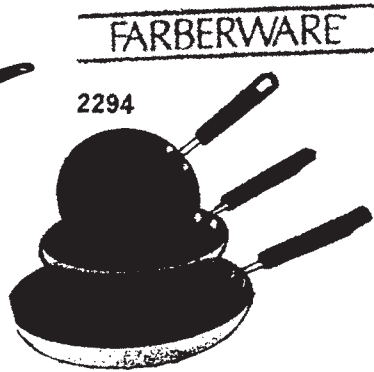

2294

- 2294 Farberware® Value-Pack Skillets - This triple pack includes 8", 10" & 11" skillets made of even heating aluminum with a non-stick coating inside and out, comfortable, non-slip cool touch handles, *a great value!* 25.95
- 2293 Farberware® Triple-Pack - this pack includes 8" and 9" skillets plus an 11" square griddle. All made with even heating aluminum with a non-stick coating inside and out, non-slip cool touch handles, *a great buy!* 28.95

MISCELLANEOUS COOKWARE

- 2248 Farberware Stainless Steel Double Boiler - 2 qt. capacity, superior 18/8 stainless steel, rolled edges for durability, heat resistant handles and knob, Farberware quality built-in \$ 35.95
- 2288 Non-Stick Double Boiler - 2 qt. covered saucepan with a 1½ qt. insert, durable non-stick coating inside and out, easy to clean, stay cool handle, glass lid 17.95
- 2286 Universal Double Boiler Insert - fits pans from 2 qt. to 4 qt., non-stick interior, easy grip handles, made of sturdy aluminum, for gentle heating of sauces, from Nordicware, *New!* 14.75
- 2291 Double Burner Griddle - heavy gauge cast aluminum with non-stick coating on both sides for easy clean-up, one side flat, one side ribbed, large 19" x 11" size 20.75
- 2289 Nordic Griddle King Double Burner Griddle - provides even heating from sturdy aluminum construction, large 17" x 10" size, non-stick coating on all sides for easy clean-up 21.95
- 2292 Nordic High Sided Double Griddle - non-stick coated interior, large 20" x 11½" x 1-3/8" deep, superior quality aluminum for even heating, made in the U. S. A., *New from Nordicware!* 24.95
- 2226 CoverAll - fits 8", 10" & 12" fry pans, by Wearever 9.75
- 2227 Universal Lid - fits 8", 10" & 12" fry pans, high dome stay cool knob, non-stick coating, adjustable vented knob, easy clean-up, *New design!* 10.75



2286



2291

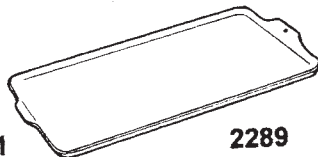

2289



2292

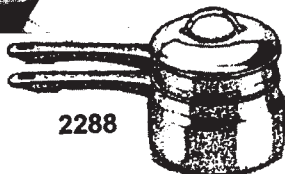

2227

NORDICWARE

New Design!

Vented Top!

2227



2226

CoverAll fits 8", 10" and 12" pans!

INTERNATIONAL COOKWARE

- 2382 Deluxe Stir-Fry Pan - heavy-gauge carbon steel for professional cooking, Excalibur® non-stick coating is safe for metal utensils, heats quickly and evenly, Large 12" size, flat bottom fits any stovetop, natural wood handle with hang-up ring \$ 29.75
- 2384 Classic Stir-Fry Pan - heavy-gauge carbon steel for cooking the natural way, large 14" size with helper handle, natural wood handle for a comfortable grip, handy hang-up ring 22.75
- 2296 Farberware Specialty Stir Fry Pan - heavy gauge aluminum for even heating, non-stick coating inside and out, Silicone enhanced handle for safety and comfort, 10" diameter 21.75
- 2383 Stir Fry Pan, Non-Stick - 12" diameter, flat bottom for gas or electric burner and efficient stir frying, durable Xylan® non-stick coating inside and out, natural wood handle 15.75
- 2385 Stir Fry Pan, Non-Stick - 9½" diameter, for small cooking tasks, same features as #2383, *New!* 14.50

- 2387 Bamboo Tool Set, 3 Piece - includes 13" slotted spatula, 12" stir-fry spatula, 9" rice paddle 6.50
- 2388 Wire Skimmer - 5" wire bowl, sturdy handle 6.75
- 2389 Chopsticks - 10 pair of wooden chopsticks per pkg. 2.55

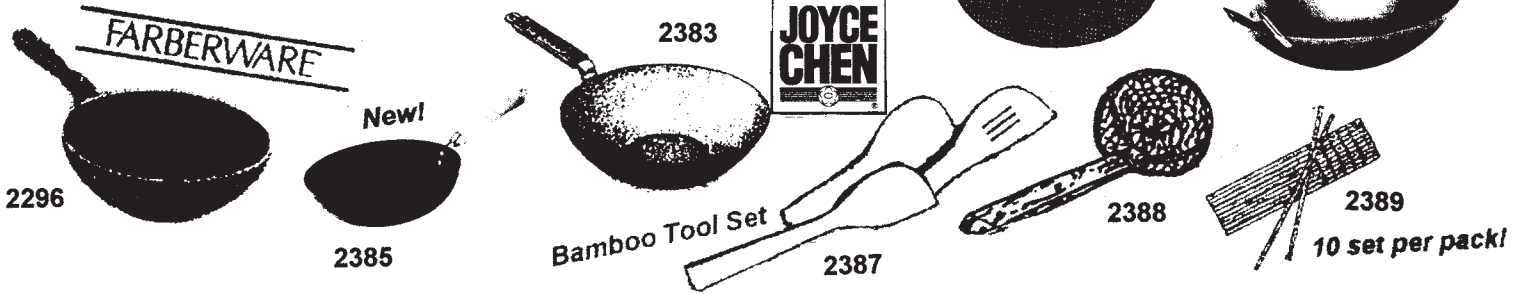

- 4262 Presto Electric Wok - Durable stainless steel body and handles with aluminum-clad base to provide fast, even high-temperature cooking. Tempered glass cover, 1500-watt heating element provides the searing temperature needed for stir-fry cooking, cool-touch twin handles, approx. 5.5 qt. capacity, wok and cover are dishwasher safe, *Great Product from Presto!* 72.95
- 4162 West Bend Electric Wok - 6 quart capacity with premium non-stick interior, quality aluminum construction and variable temperature settings provide fast, even heating, steaming rack included, 1500 watts, with recipe booklet 69.75



- 2392 Deluxe Pizza Stone - Professional quality 3/4" thick pizza stone gives superior results on all baked goods, large 16" x 14" size, porous to absorb moisture producing crisp crusts, seasons itself overtime for better performance, *New from Cucina Pro!* 39.95
- 2391 Pizza Stone - with Rack - 15" diameter ceramic stone provides uniform heat distribution and moisture absorption giving pizza or bread that classic crisp crust. Chrome serving rack included 18.75
- 2395 Pizza Peel - 12" x 14" aluminum blade with wood handle, blade is triple riveted to stay permanently attached to the handle, use to put-in and remove pizzas or baked goods to a baking stone in the oven, 26" overall length 20.75
- 4379 Imperia Pasta Machine - made in Italy, 2 cutting attachments; narrow or broad, 6 thickness settings, makes perfect spaghetti, noodles, fettucini and more, recipe booklet included, professional quality!, *The Original Heavy Duty Quality!!* 62.75
- 4378 Al Denta Pasta Machine - value priced for the budget conscious, 6" wide cutting head, rolls dough and cuts spaghetti or fettuccini, stainless steel construction 29.95

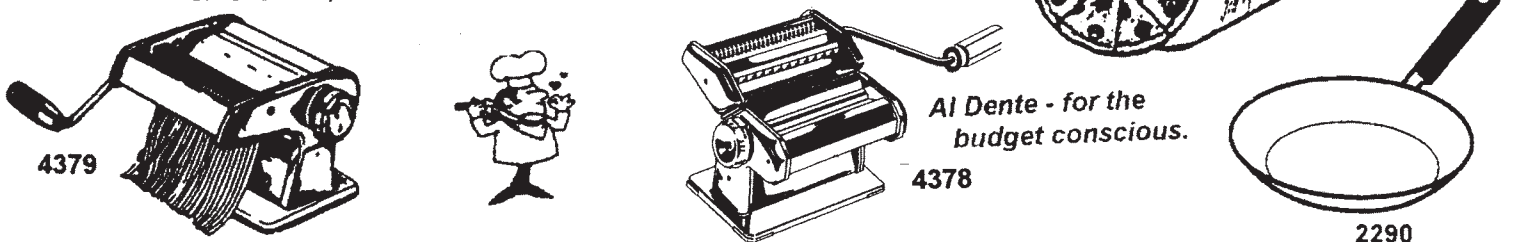

- 2290 Crepe Pan - non-stick surface inside and out, 9½" diameter, sloped sides makes for easy removal of finished crepe, stay cool handle, from NorPro, two recipes included 9.95

HISPANIC COOKING

- 2489 Paella Pan - 14" diameter, red enamel exterior, non-stick coated inside for easy clean-up, Thermospot technology tells you when the pan is properly heated, stay cool handles 25.95
- 2480 Tortilla Press - makes 6" tortilla with a simple press, sturdy aluminum construction 11.75
- 2481 Tortilla Bowl, 7" - set of 2, non-stick pans make 7" tortillas bowls - just like in the restaurant - but baked not fried! Also great as a mold for dessert or bread, recipes included 11.95
- 2482 Tortilla Bowl, 4½" - set of 4, non-stick pans, perfect for serving fajita or taco condiments, making individual desserts, recipes included 9.50

Make your own
tortillas or tacos!



2489

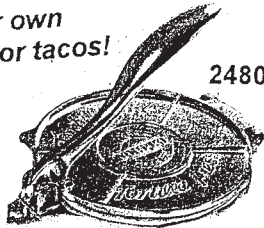

2480



2481



2482

In 4½" or 7" sizes!

COOKING APPLIANCES



- 4326 Rival Rice Cooker, 10 cup - automatic cook and keep warm functions, 10 cup (finished) capacity, removable non-stick bowl, use steamer basket to steam vegetables while the rice cooks! Tempered glass lid with steam release vent, white, includes recipes and steaming times 29.95
- 4274 West Bend® Electric Fondue Set - 3 quart fondue pot has adjustable temperature control for meat, cheese or dessert fondues. Premium non-stick interior and exterior, easy to clean, unit is immersible and dishwasher safe with temperature control removed, heat resistant handles, removable fork ring and 8 - fondue forks, recipe booklet included 49.75
- 4321 Nesco Electric Pressure Cooker - Programmable with presets, self-locking lid with automatic pressure release, 6 quart capacity, removable dishwasher-safe non-stick cooking insert, LED display with soft-touch buttons, slow cook up to 9½ hrs., brushed stainless exterior, *New Lower Price!* 79.50

RIVAL

Rice Cooker, 10 cup

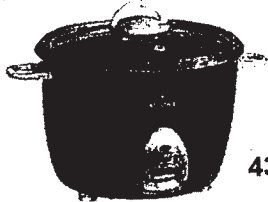

4326

WEST BEND

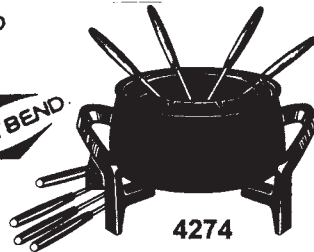

4274



4321

RIVAL

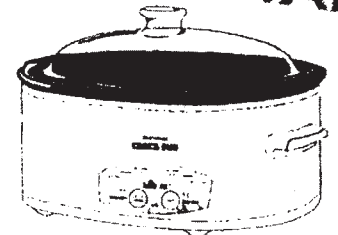

4270

SLOW COOKERS

- 4270 Rival Crock Pot®, 5.5 Qt. Smart-Pot™ - removable oval stoneware crock, electronic control allows you to set start time and the smart pot does the rest, warm setting is automatically activated when cook time is complete, attractive white exterior, Rinse-Clean™ Lifetime Non-Stick Coating on ceramic stoneware, dishwasher safe crock & glass lid, recipes included 44.50
- 4271 Hamilton Beach 6 Qt. Slow Cooker - large 6 quart removable oval ceramic crock, convenient lid rest keeps lid out of the way when stirring or serving, large cool touch handles, 3 temperature settings, glass lid, on/off indicator light, white 44.95
- 4269 West Bend 7 Qt. Crockery™ Cooker - large capacity removable crock doubles as a serving dish, dishwasher safe, 3 heat settings for maximum cooking control, glass lid, *New!* 46.95
- 4243 Rival Crock Pot®, 5 Qt. - round design, removable 5 quart stoneware crock for easy clean up, 2 heat settings plus keep warm feature, glass lid, white floral exterior, recipes included 33.75
- 4273 Rival Crock Pot® 4 Quart - round design, removable 4 qt. stoneware crock for easy clean-up, 2 heat settings, crock and glass lid are dishwasher safe, stainless steel exterior, with recipes. 30.95
- 4369 West Bend Versatility™ Slow Cooker - handy 5 quart capacity, perfect for roasting, slow cooking, warming and serving. Cooking pot is safe for freezer, oven and stove top use, base doubles as a light-duty non-stick griddle, adjustable temperature control, glass lid, *New!* 49.75

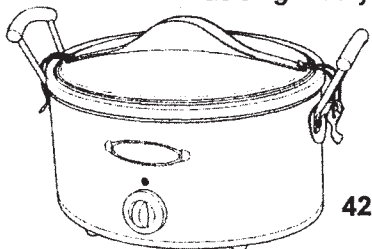

4271

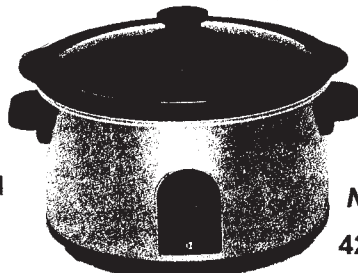

New!
4269



4243

West Bend®

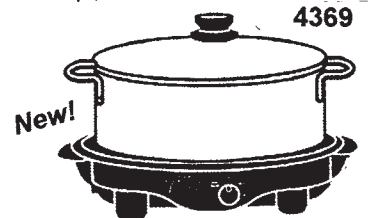

New!
4369

ELECTRIC FRY PANS

- 4154 Presto Jumbo Electric Fry Pan - extra large 16" x 11", Presto Control Master maintains uniform heat, submersible pan has removable thermostat for easy clean up. Non-stick coating on interior & exterior base, high dome cover is self basting, will not dent or warp, dishwasher safe ..\$ 50.75
- 4160 West Bend Deep Oblong Skillet - 12" x 15" x 3" deep skillet, tilt leg for draining & healthier cooking. Non-stick interior for quick food release and easy clean-up, removable temperature control, heat resistant glass lid with steam vent, power on light, white, *New!* 52.75
- 4256 West Bent Deep Electric Skillet - 12" size, 3" deep, tilt leg for draining & healthier cooking. Non-stick interior for quick food release and easy clean-up, removable temperature control, heat resistant glass lid with steam vent, power on light, white 44.95
- 4156 West Bend Automatic Skillet - large 12" skillet with non-stick interior surface, heavy gauge aluminum heats food quickly and evenly, accurate temperatures are maintained by Senso-Temp heat control, removable heat control lets skillet be washed in dishwasher or sink, heat resistant handles and legs, heats to 425° F, all metal cover, cookbook included 48.75
- 4157 Presto Electric Skillet - generous 11" size with hard, non-stick surface inside and outside for easy cleaning, adjustable temperature control is removable, metal cover, dishwasher safe 33.95
- 4257 Presto Stainless Steel Skillet - 12" round design, stainless steel body and handle, aluminum clad bottom for even heat distribution, tempered glass cover, fully immersible and dishwasher safe, Control Master® heat control maintains proper cooking temperature, *New Lower Price!* 67.50



*Comes in 12" x 12" or
12" x 15". All 3" deep!*



4256

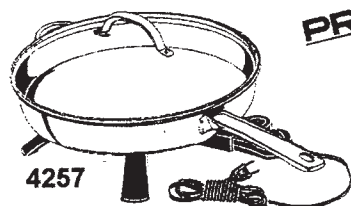

4257



4157

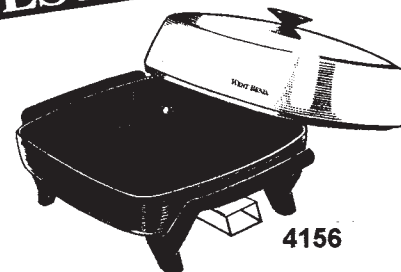

4156

New Lower Price!

GRIDDLES

- 4166 Presto Cool Touch Griddle, Black - cool-to-the-touch polyester rim surrounds 20" x 10½" cooking surface, convenient backstop for easy removal of burgers, pancakes and more, premium non-stick surface, slide-out drip tray, Control Master® adjustable temperature control (150-400°F), completely immersible for easy clean-up 38.75
- 4170 BigGriddle™ Cool Touch Griddle - from Presto, extra large 19" x 15" cooking surface, 33% larger than most other griddles, Control Master® heat control automatically maintains proper temperature, premium non-stick cooking surface ensures stick-free cooking and easy clean-up. With tilt-n-drain feature! Slide-out drip tray empties easily, fully submersible, 1500 watts 54.75
- 4165 West Bend Family Griddle - convenient 18" x 10" size, sturdy cast aluminum construction with non-stick surface. Adjustable control keeps selected temperature, grease trap along edge catches juices and two pouring lips make disposal easy, convenient back stop for easy food removal, tilt legs for easy draining, heat resistant handles, heat control is detachable for fully immersible cleaning, 1470 watts 37.95

BigGriddle™

4170

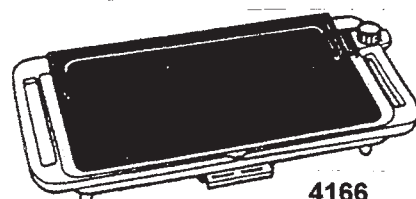

4166



4165



ELECTRIC FRYERS

- 4158 Presto Fry Daddy Electric Deep Fryer - large size fryer, easy to use, easy to clean, easy to store. Makes 4 generous servings with only 4 cups of oil. Automatic temperature control for perfect results. Snap on storage lid included. Let's you store oil for easy re-use. No odor! Non-stick surface inside & out for easy clean up \$ 33.75
- 4171 Presto Stainless Steel Deep Fryer - 1.1 quart capacity, fries with the cover closed to reduce odors and spattering, brushed stainless steel exterior, anodized aluminum interior for fast uniform heating, cool touch cover with built-in screen, adjustable thermostat, indicator light 35.95
- 4159 Presto Kitchen Kettle - this 6 serving multi-cooker can roast, braise, blanch, boil, deep fry, stew, steam or simmer. Control Master® heat control maintains accurate cooking temperature, nonstick finish inside & out, completely immersible for easy cleaning, includes glass cover and steam/fry basket 36.75



DEEP FRYERS

- 4167 Presto CoolDaddy® Deep Fryer - cool touch exterior for safety, large 6 serving capacity, seal-tight cover eliminates spatters and reduces odors, exterior basket handle lowers basket as lid closes, large viewing window easy select thermostat settings, removable Basket for easy clean-up, white 56.95

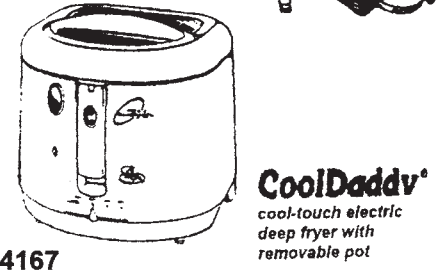

- 4327 Nesco Professional 18 Qt. Roaster - Bake, roast, cook or slow cook in one portable unit. Large capacity, enough even for a 22-lb turkey, non-stick interior, removable for cleaning, patented Circle of Heat technology, automatic temperature control, on light, rack with lift out handles sturdy aluminum cover, stainless steel exterior, 74.95
- 4330 Nesco 18 Qt. Roaster - Ivory porcelain exterior, same features as the professional model 59.50

PORTABLE BURNERS - by Deni. Brushed stainless steel exteriors, heavy duty cast iron heating surface - 7" diameter. Adjustable thermostat, safety on/off dial, use with any flat bottom cookware: metal, glass, ceramic, woks or tea kettles.

- 4190 Deni Single Burner - 1,500 watts 35.50
- 4191 Deni Double Burner - 1,800 watts, separate controls 46.50

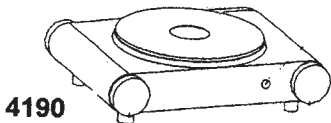

deni

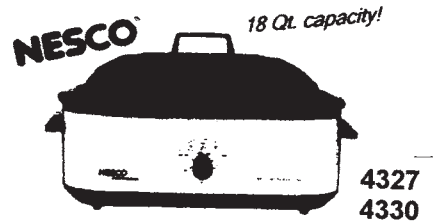
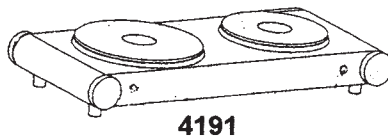

- 4331 Cuisinart Griddler® Compact Grill - Prepare restaurant quality grilled items and traditional panini. Use as a contact grill, panini press, full grill, full griddle or half grill/half griddle! removable and reversible dishwasher safe non-stick cooking plates, adjustable temperature control, large 11½" x 9¼" cooking surface, gourmet recipes included 87.50
- 4329 Cuisinart Panini Grill - Prepare traditional restaurant quality Panini, golden brown and crispy. Floating hinges adjust to correct thickness, preset temperature control automatically heats cooking plates to the perfect temperature. Non-stick plates for easy clean-up, 11" x 7" size 59.95

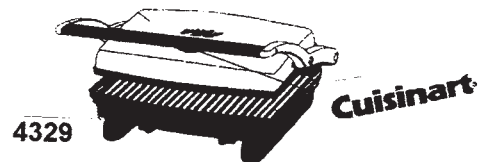
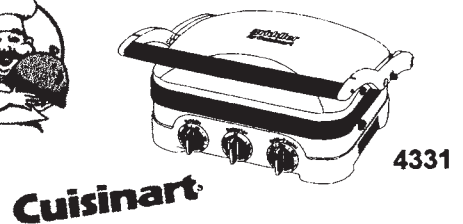

This catalog supercedes all others and is in effect until 11/01/2012. Prices are subject to change without notice due to market conditions. We reserve the right to substitute comparable items where and when necessary. Our terms are NET 30 days. Our minimum order is \$20.00. All orders will be assessed only a handling charge of \$6.95 for orders under \$400 or \$9.95 for all orders \$400 and more. NO FREIGHT CHARGES. Any merchandise returned to us is subject to a 10% restocking charge at our option.

MICROWAVE OVENS

PANASONIC MICROWAVE OVENS – Inverter technology perfects the art of cooking with microwaves.

The consistent delivery of microwave energy means better more accurate cooking. One-touch sensor cook and reheat, keep warm feature, push button control panel and push-button door release, and many more features.

- 4393 Panasonic Prestige Microwave Oven, 1.6 cu. ft. - 1250 watts, white \$ 229.95
 4394 Panasonic Microwave Oven, 1.2 cu. ft. - 1300 watts, white 159.95

- 4398 Cuisinart Microwave Oven - 1.0 cu. ft. capacity, 1,000 watts, stainless steel control panel, door has dark tinted window, rotating 12" glass tray, touch pad controls with LCD read out, two convenient defrost functions, eight preset options with serving size choices for each, stainless steel interior and exterior for easy cleaning, 169.75

Panasonic

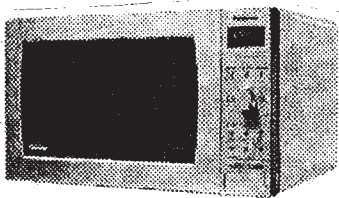

4393

- One touch sensor cooking
- Push button control panel
- Reheat & keep warm features

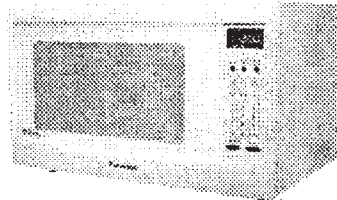

4394

Cuisinart

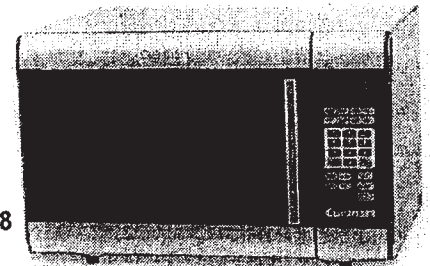

4398

- 4396 Haier Microwave Oven, 1.1 cu. ft.– 1,000 watts of power, 10 power settings, 8 one touch menu buttons, memory cook settings, weight & time defrost, push button control panel, white 119.50
 4397 Haier Compact Microwave Oven - 0.7 cubic foot capacity, 700 watts, two-stage cooking operation, touch pad controls, convenient defrost functions by time or weight, rotating glass tray, 105.75



Haier America

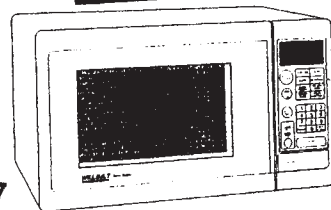

4397

New



Haier America

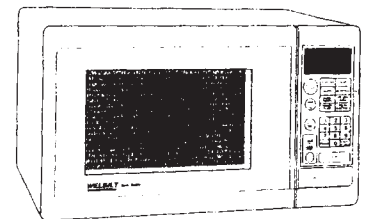

4396

Check our website for outside dimensions of all the microwave ovens. www.sanefcs.com

MICROWAVE COOKWARE

- 2471 Rice & Pasta Cooker Set - 12 cup capacity, great for rice, pasta or vegetables, includes container, steamer basket, vegetable rack, specially designed lid, plus extra gadgets to make microwave cooking easier, 17 pieces in all! From Progressive 14.75
 2473 Fish & Vegetable Steamer - easily steams vegetables or fish, adjustable steam control vent, 1 quart capacity, see thru lid, machine washable, from Progressive 10.75
 2477 Microwave Food Cover - dome contains splatters, steam vents and center finger grip, 10¼" dia., 3.95
 2475 Bacon Rack - slanted design drains fat and grease away from all types of meat, large 12" x 10¼" size, great for defrosting, from Nordic Ware 9.95
 2476 Nordic Reversible Bacon/Roast Rack - 10" round, reversible, smooth side for pizza and nachos, ribbed side for bacon and meat, oven safe to 400°F, dishwasher safe, *New!* 7.95
 5004 Microwave Covers - package of 4 (1 large, 1 medium & 2 small sizes), prevents splatter, replaces sticky plastic wraps, vents steam, ideal for reheating, FDA approved, reusable 2.95



12 cup capacity!

2471

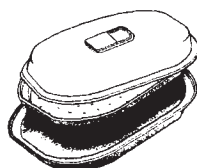

2473

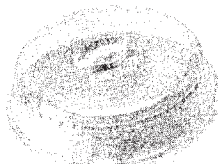

2477

Covers plates up to 10" wide!

New



2476

NORDIC WARE®

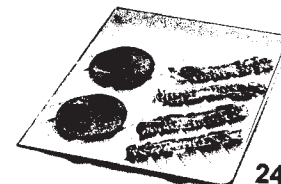

2475



5004

COOKING GADGETS

OXO Good Grips Flexible Nylon Turners - pliable, colorful nylon blade will not scratch cookware, heat resistant to 400°F, soft comfortable non-slip handle, dishwasher safe.

- 1688 OXO Flexible Turner, Black \$ 6.50
- 1689 OXO Flexible Turner, Blue 6.50
- 1690 OXO Flexible Turner, Red 6.50
- 1691 OXO Flexible Turner, Green 6.50
- 1692 OXO 4 Piece Turner Set - one of each of the above four colors 23.75
- 1682 OXO Good Grips Flexible Turner - stainless steel blade, flexible for better control, non-slip handle 6.50



OXO Silicone Flexible Turners - Thin, flexible edge glides easily under foods, silicone bonded to flexible stainless steel, heat resistant to 600°F, safe for all non-stick cookware, soft comfortable non-slip handle, dishwasher safe. *Super Flexible!!*

- 1651 OXO Silicone Jumbo Turner - extra wide 6" blade, slotted 7.65
- 1652 OXO Silicone Slotted Turner - extra long 6½" blade, slotted 7.65
- 1653 OXO Silicone Solid Turner - solid blade, 6" long 7.65



- 1687 OXO Good Grips Potato Masher - ergonomically designed soft handle, stainless steel disc with double rod construction, dishwasher safe 9.90
- 1697 Ekco 123 Nylon Potato Masher - 10" long, safe for all types of cookware 4.95
- 1348 Health Steamer, 9" - stainless steel, collapsible for easy storage, fits all size pots, steam fresh vegetables or fish, locks in vitamins and minerals 4.95
- 1185 Splatter Shield - 11" diameter screen, keeps splattering grease from burning hands or stovetop, dishwasher safe, plastic handle 3.20
- 1186 Deluxe Splatter Shield - extra large 13" diameter, non-stick mesh, with soft grip handle 7.95

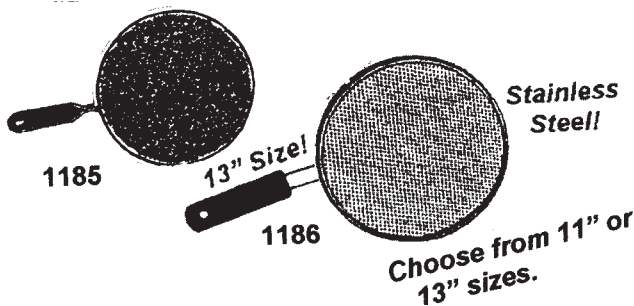

COLANDERS/STRAINERS

- 1143 Stainless Steel Colander - 3 quart capacity, gleaming stainless steel will not rust, sturdy handles 5.95
- 1144 Stainless Steel Colander - 5 quart capacity, base ring for stability, rustproof 7.95
- 1142 Plastic Colander - 11" diameter, features easy grip handles, 6.5 qt. capacity, dishwasher safe 4.95

CLASSIC KITCHEN STRAINERS - textured white handles for a sure grip, fine wire mesh strainers, dishwasher safe.

- 1633 3" Strainer 2.95
- 1627 6" Strainer 4.50
- 1631 8" Strainer 6.75

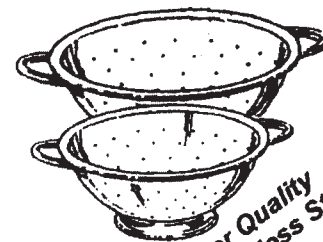
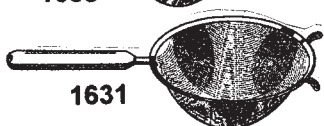

Sunbeam



www.sanefcs.com

UTENSILS

HAMILTON BEACH HEAVY DUTY STAINLESS STEEL TOOLS - Made of top quality stainless steel with shock resistant phenolic handles securely attached with triple rivets.

1601	Slotted Turner	\$ 4.75
1603	Slotted Spoon	4.75
1604	Basting Spoon	4.75
1605	Deep Ladle	4.95
1606	Pasta Server	4.95
1609	5 Piece Tool Set - includes one each of the above	21.75

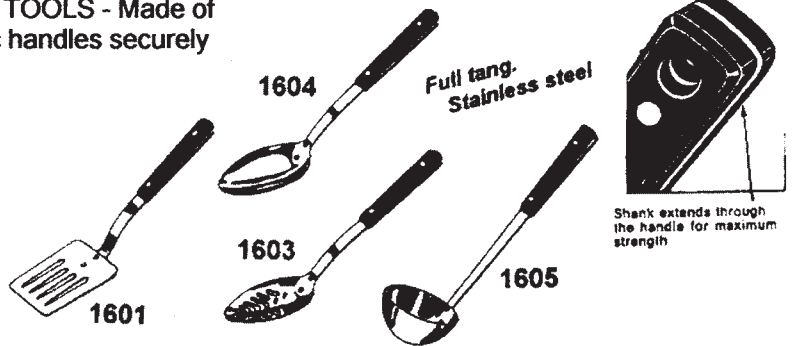

RUBBERMAID COMFORT ZONE™ COOKING TOOLS - Constructed for quality and durability. Soft non-slip grip, heat resistant nylon is safe to 450°F, 13" long, dishwasher safe.

1641	Rubbermaid Slotted Turner	3.95
1642	Rubbermaid Pancake Turner - 5¾" wide blade ..	4.95
1643	Rubbermaid Slotted Spoon	3.95
1644	Rubbermaid Basting Spoon	3.95
1645	Rubbermaid Deep Ladle - 4 oz.	4.95
1649	Rubbermaid 5 Pc. Tool Set - includes one of each of the above tools	19.95
1646	Rubbermaid Griddle Turner - slotted, 11½"	3.40
1647	Rubbermaid Spatula - 11¾ length	4.35

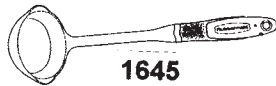
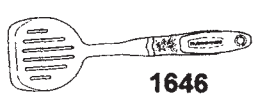
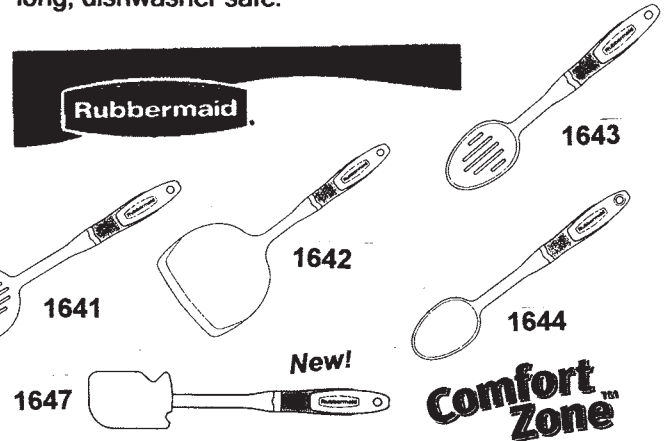

NYLON COOKING TOOLS - Safe for non-stick surfaces, all are heat resistant to 450°F, comfortable grip, black. All are 12" long.

1671	Nylon Slotted Turner	1.95
1673	Nylon Slotted Spoon	1.95
1674	Nylon Basting Spoon	1.95
1675	Nylon Ladle	1.95
1676	Nylon Spaghetti Server	1.95
1679	5 Piece Nylon Tool Set - includes one of each as above	8.75

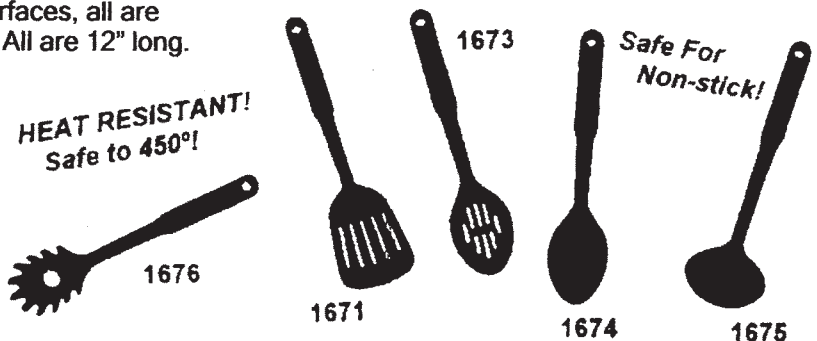

CLASSIC KITCHEN TOOLS - Textured black handles for good looks plus a sure grip, made of durable, dishwasher safe polypropylene. Flat tapered chrome plated stalks for strength.

1621	Slotted Turner - 12¾" long	2.10
1623	Slotted Spoon - 12¾" long	2.10
1624	Basting Spoon - 12¾" long	2.10
1625	Ladle - 2.5 oz. bowl	2.10
1626	Two Tine Fork - 12¾" long	2.10

Sunbeam



STAINLESS STEEL LADLES - One piece 18/8 stainless steel construction, resists breaking, hooked handle, capacity permanently marked on handle, NSF approved, food service quality, by Vollrath.

3502	Ladle, 2 oz.	2.95
3503	Ladle, 3 oz.	3.35
3504	Ladle, 4 oz.	3.95
3505	Ladle, 6 oz.	4.95

VOLLRATH®

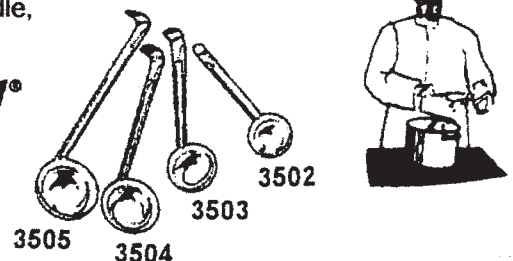

NSF approved,
food service quality!

J. A. HENCKELS INTERNATIONAL FINE-EDGE PRO CUTLERY - High quality stainless steel blades are rust and stain resistant, full one-piece tang construction, blades can easily be re-sharpened!, triple riveted, black satin poly handles are sturdy and hygenic. *A TERRIFIC VALUE!!*



- 1715 3" Parer \$ 7.95
- 1716 5" Utility Knife 8.95
- 1717 8" French Chef Knife 13.50
- 1722 5" Santoku Knife - small blade
for smaller hands 12.50
- 1720 8" Bread Slicer - serrated blade 12.75
- 1723 9" Sharpening Steel 11.75
- 1719 7 Piece Block Set - includes 3" parer, 5" serrated
utility, 8" french chef, 7" Santoku hollow edge,
kitchen shears, 9" sharpening steel
and 6 slot hardwood block 66.75

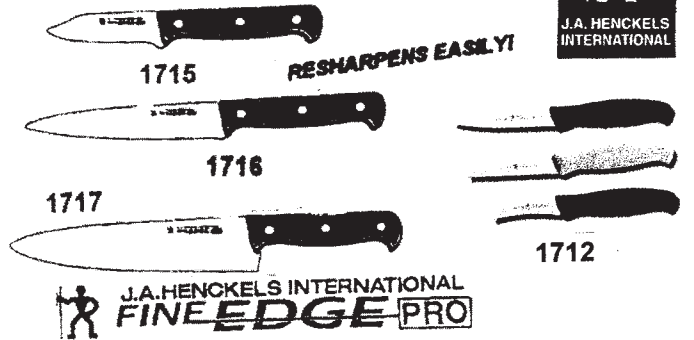

- 1710 2 Pc. Santoku Set - includes 1 ea. 5" &
7" santoku knives, *a great value!* 19.95
- 1724 3 Pc. Starter Set - includes 3" parer,
5" utility & 8" French Chef Knife 28.95
- 1711 4 Pc. Paring Knife Set - includes 2" peeling knife,
3½" parer, 3" vegetable knife and 5" serrated
utility knife, *each with a different color handle!*... 16.95
- 1712 3 Pc. Paring Knife Set - includes 2" peeling
knife, 3½" parer & 3" vegetable knife 10.95

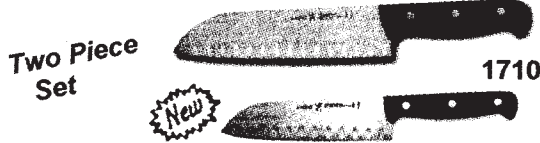

- 1721 Henckels Instructional Knife Skills DVD - featuring Chef Jim Shiebler who has taught at the California Culinary Academy, the Le Cordon Bleu school, and worked at six of the leading hotels of the world. Learn the purpose, usage and safest grip of each knife, approximately 40 minutes, 7.95

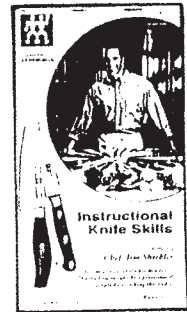

1721 DVD

ONEIDA® CLASSIC CUTLERY - High carbon stainless steels blades are tapered ground for superior sharpness. Blades are resistant to stains, rust and pitting, triple rivets for safety, comfortable handles for easy handling, *New from Oneida@!*

- 1761 Classic Parer - 3" length 5.95
- 1762 Classic Utility Knife - 5" length 6.20
- 1763 Classic French Chef Knife - 8" length ... 9.95
- 1764 Classic Santoku Knife - 7" length 9.95
- 1765 Classic Bread Slicer - 8" length 9.95

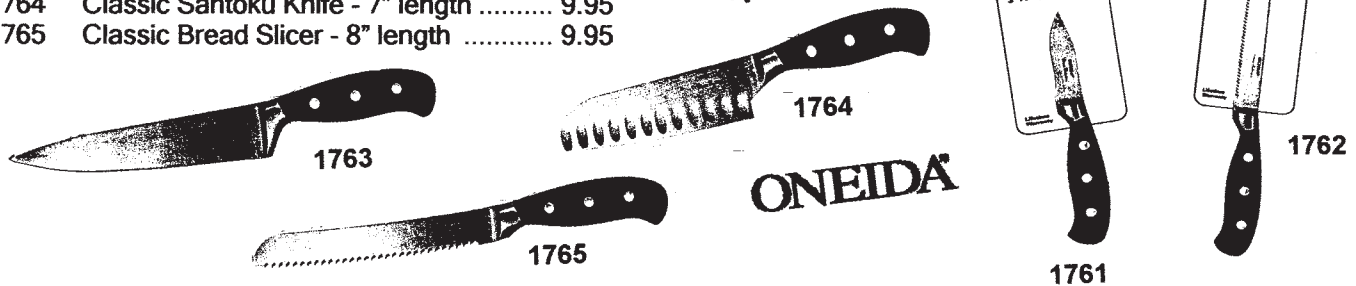

UNIVERSAL KNIFE EDGE GUARDS - Designed to protect your knife edges and your fingers, Made of durable polystyrene with flared top edge to easily and safely insert your knife.

- 5701 Knife Edge Guard - 4.5" long, pink 2.25
- 5702 Knife Edge Guard - 7.5" long, red 2.75
- 5703 Knife Edge Guard - 8" long, blue 3.45
- 5704 Knife Edge Guard - 10½" long, green 4.95
- 5705 Knife Edge Guard Set - 4 pcs. (one of each of the above)
Save Over 20% off the each prices!! 9.95

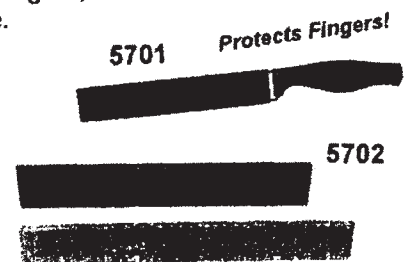

Knife guards protects from accidental cuts during storage!

5703

MUNDIAL FOOD SERVICE QUALITY CUTLERY - White molded polypropylene handles for sure grip, stainless steel blades stay sharper longer, then take sharpening well. **NSF APPROVED!**
"Use what the Pros use!". Restaurant quality - a terrific value for the money!

- 1731 3¼" Parer, Chef Style \$ 4.75
- 1733 4" Parer, Spear Point 4.25
- 1735 6" Boner - narrow blade, stiff..... 9.95
- 1736 6¼" Utility Knife 10.35
- 1734 6" Utility Knife, Wavy Edge - serrated 9.50

- 1740 7" Santoku Knife - with Granton edge
for non-stick cutting 21.75
- 1737 8" French Chef's Knife 17.95
- 1728 10" French Chef's Knife 20.95
- 1738 8" Bread Slicer, Wavy Edge 12.50
- 1726 10" Bread Slicer, Wavy Edge 11.95

- 1739 10" Sharpening Steel - round 18.75
- 1730 Dough Cutter/Scraper - 6" blade 9.95

- 1746 Baker's Icing Spatula - 8" blade 9.50
- 1742 Baker's Large Icing Spatula - 10" blade 9.95
- 1744 Turner - 4" x 3", chisel edge..... 10.75

KNIFE HOLDERS

- 1749 Mundial Magnetic Knife Holder - 12" length,
extra strong magnet holds all sizes 11.95
- 1748 Mundial In-Drawer Knife Holder - solid
hardwood with 4 large slots, 6 small
slots and 1 steel slot, 17" x 7" 29.95
- 1747 Knife Organizer - safely organize knives in
any drawer, protects blades from damage,
easy to use, no tools needed! 9.95



1747
Expands to fit
any size drawer!

Magnetic Knife Holder!



1749



Solid maple! 1748

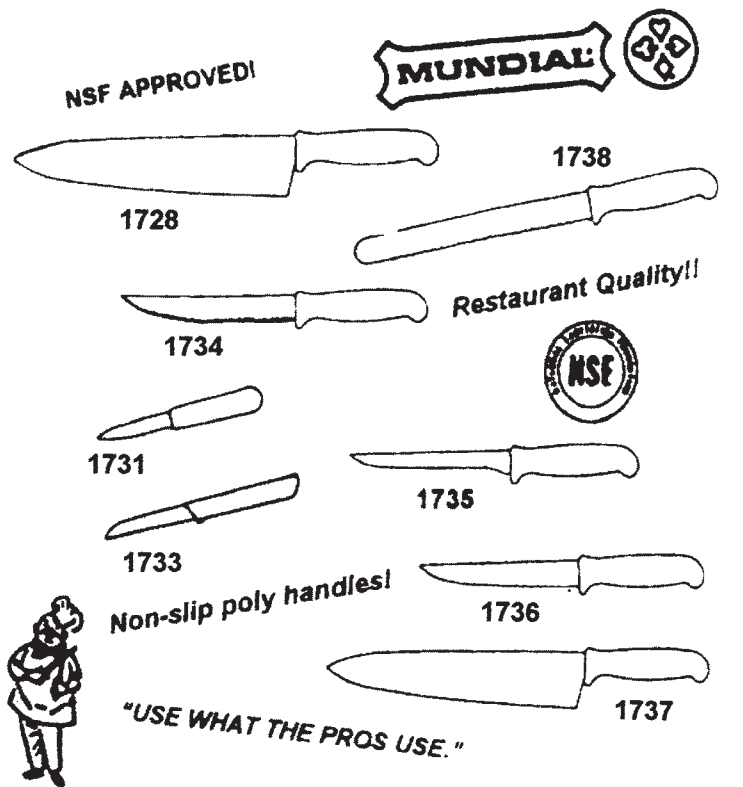

Sharpen easily!

Non-slip poly handles!

"USE WHAT THE PROS USE."

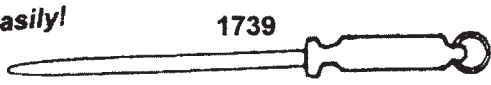

1739

Textured grip white handles!

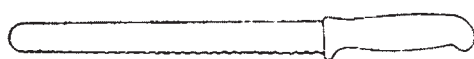

1726

NSF approved design!

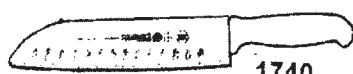

1740



1744

1730

OXO GOOD GRIPS CUTLERY - Specially designed cushion grip, Rubber-soft Santoprene® handles are non-slip, wet or dry. All blades are stainless steel with a fine-edge finish. Dishwasher safe. Handles are designed for a superbly comfortable grip.

- 1701 Paring Knife - 3½" blade \$ 5.75
- 1703 Utility Knife - 5" serrated blade 5.90
- 1704 Santoku Knife - 6½" blade, Granton edge 9.95
- 1705 Mini Santoku Knife - 4" blade, Granton edge 6.95
- 1706 Chef's Knife - 8" blade 9.95
- 1707 Slicing Knife - 8" blade 7.70
- 1708 Bread Slicer - 8" serrated blade 7.95



1706



1708



1704

Cushion grip handles!



1707



1701



1703



1705

Granton Edge - scallops allow air to enter between the blade and the cut product thereby not sticking to the knife.

METROPOLITAN CUTLERY by CHICAGO CUTLERY® - Professional stainless steel patented taper grind blades with full tang construction, triple rivets, comfortable grip, ergonomically designed black polymer handles.

- 1714 Metropolitan 8 Pc Set - includes 2¾" & 3½" parers, 5½" utility, 7½" chef knife, 8" slicer, 8" sharpening steel, kitchen shears and wood block \$ 59.75
- 1713 Metropolitan 3 Pc. Set - includes 3½" parer, 5" Utility & 7½" chef knife 25.95

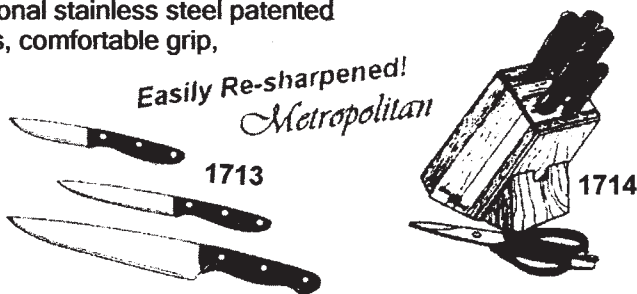

CHICAGO CUTLERY® WALNUT TRADITION CUTLERY - Patented taper grind edges provide extra fine cutting edge, high-carbon stainless steel resists rusting, contoured walnut handles provide comfort and safety. Triple rivets and full tang blades for strength and stability.

- 1785 Traditions 3" Parer \$ 9.50
- 1786 Traditions 3" Parer/Boning 9.55
- 1787 Traditions 6" Utility 12.95
- 1788 Traditions 8" Chef Knife 15.75

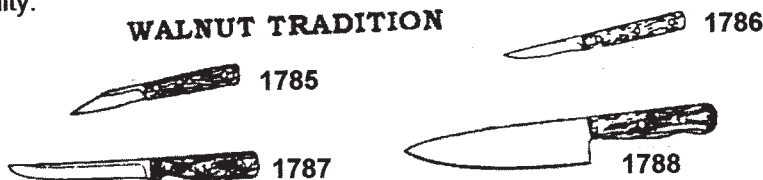

CHICAGO CUTLERY® ESSENTIALS CUTLERY - Stainless steel blades with triple riveted polymer handles, full tang for strength, can be easily re-sharpened. Each knife comes with it's own protective sheath for safety! *New from Chicago Cutlery!*

- 1755 Essentials Paring Knife, 3½" 4.25
- 1756 Essentials Utility Knife, 4¾" 4.75
- 1757 Essentials French Chef Knife, 8" 6.95
- 1758 Essentials 3 Pc. Set - includes one of each of the above 12.95
- 1759 Essentials Santoku Knife, 5" 5.50
- 1760 Essentials Bread Slicer, 8" 6.25



Also available in a 3 Piece Set!

Each comes with it's protective sheath!

Chef's Choice

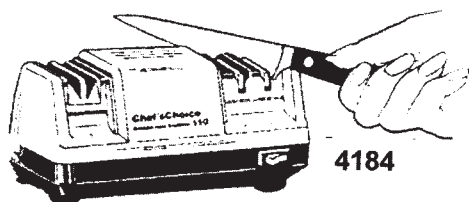

- KNIFE SHARPENERS**
- 4184 Chef's Choice Professional Sharpener - exclusive three stage process produces the sharpest triple bevel edge on any knife. Sharpens all fine edge and serrated knives!, use on stainless or carbon steel cutlery. From Edgecraft, Model #320 89.95
 - 4185 Chef's Choice Knife Sharpener - put incredibly sharp edges on kitchen knives. Uses orbiting diamonds and patented magnetic guides to insure better than professional results with amateur simplicity, from Edgecraft, Model #310 55.75
 - 4181 Edgeware™ Pro Electric Sharpener - Interlocking diamond abrasive wheels sharpen both sides of the blade at the same time, can be used manually for serrated blades, rubber hand grip for comfort and control, non-slip feet 39.75
 - 4182 Edgeware™ Compact Electric Sharpener - synthetic sharpening wheel offers quick edge setting capability, blade guide holds knife at correct angle, can be used manually! 28.50
 - 4187 Edgeware™ Manual Knife Sharpener - coarse and fine stages, for straight or serrated edges, flip-down counter guard, soft-grip handle for comfort and control, non-slip rubber feet for safety, sharpens scissors too 17.95

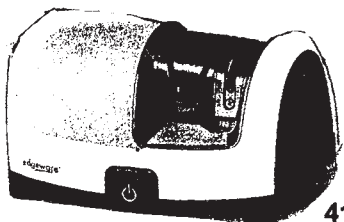
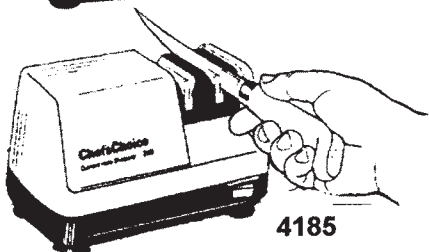

edgeware

Sharpens serrated knives!



CUTTING BOARDS

OXO CUTTING BOARDS - Soft, tapered grips make lifting board easy. Double sided use helps prevent cross-contamination, non-slip edges keeps board from slipping, dishwasher safe. All are 7/16" thick.

- 3701 OXO Prep Cutting Board - 7¼" x 10½" 7.75
- 3702 OXO Utility Cutting Board - 10½" x 14½" 12.50
- 3703 OXO Carving & Cutting Board - 14½" x 21" 18.75

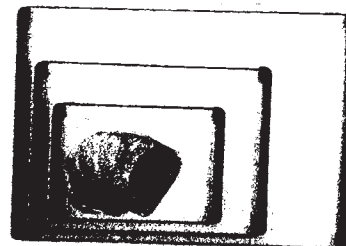

3701
3702
3703

NON-SLIP CUTTING BOARDS - Reversible two-sided cutting board, polyethylene will not dull knives, non-absorbent, non-porous surfaces, specially designed corners keep board from moving on countertops! Grooved on one side, NSF approved! All are 7/16" thick.

- 1293 Non-Slip Cutting Board, 8" x 10" 8.95
- 1287 Non-Slip Cutting Board, 10" x 14" 9.95
- 1294 Non-Slip Cutting Board, 12" x 16" 13.95

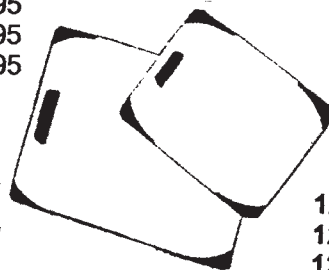

**Non-slip designs
Holds firmly to
countertop
Comes in three
convenient sizes!**

1287
1293
1294

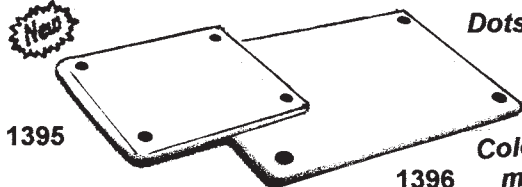

Dots are also non-slip feet!

**Colored dots to identify
meats from vegetables/fruits!**

1395

1396

SAFE SIDE® CUTTING BOARDS - Features a color coded system that helps avoid cross-contamination. Use the green coded side for cutting vegetables and fruits and the red side for meats and poultry. Non-slip, polyethylene construction.

- 1395 Safe Side Cutting Board 8" x 10" - *New!* 8.95
- 1396 Safe Side Cutting Board 10" x 14" - *New!* 13.95



NON-SLIP GRIPPER CUTTING BOARDS - Durable polypropylene cutting surface with 300 soft gripping feet thermally bonded so the board will not slip when in use! Dishwasher safe in attractive fashion colors. **NEW!**

- 1371 Gripper Board, White - 11" x 14" 13.95
- 1372 Gripper Board, Red - 11" x 14" 13.95
- 1373 Gripper Board, Blue - 11" x 14" 13.95
- 1374 Gripper Board, Green - 11" x 14" 13.95
- 1375 Gripper Board, Yellow - 11" x 14" 13.95
- 1376 Gripper Board 5 Pc. Set - one of each color board 59.95

1371

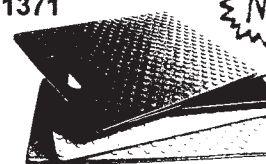

**Available in a
5 piece Set!**

1376

POLYETHYLENE CUTTING BOARDS - sturdy, white polyethylene, non-porous, will not absorb odors, liquids or bacteria, beveled edges, dishwasher safe!

- 1387 Polyethylene Cutting Board, 10" x 14" 8.95
- 1388 Polyethylene Cutting Board, 12" x 16" 12.95
- 1389 Polyethylene Cutting Board, 14" x 20" 16.95

1388



New!

1387

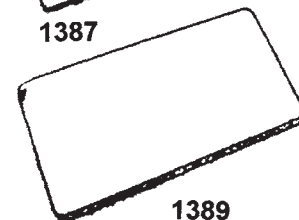

1389

ECONOMY CUTTING BOARDS - Lightweight is easier to carry and store, made of molded polyethylene, non-slip, white with colored non-slip ends. **NEW!**

- 1381 Economy Cutting Board, Red Ends - 10" x 14" 6.75
- 1382 Economy Cutting Board, Blue Ends - 10" x 14" 6.75
- 1383 Economy Cutting Board, Black Ends - 10" x 14" 6.75

Choose your color!

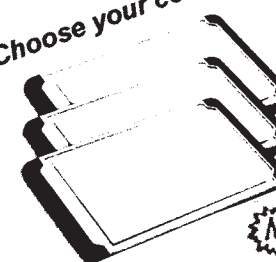

1381
1382
1383



- 1288 Non-Slip Flexible Cutting Boards - each 11" x 15" mat has a non-skid silicone base, does not absorb odors, **4 different color mats per pkg.** 6.75

- 1289 Flexible Cutting Mat - **2 per pkg.**, 11½" x 15" size, flex it, bend it, funnel it, will not dull knives, does not absorb odors, two different colors per pkg., use a different color for each food group! FDA approved 3.50

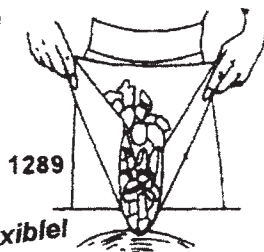

1289

Super flexible!



**Non-slip
Flex Mats, #1288!**

New Lower Price!

**Four different colors
per package.**

